

## ELECTRONIC TORQUE WRENCH WITH ANGLE OPERATING INSTRUCTIONS

### LCD Display and Button Functions

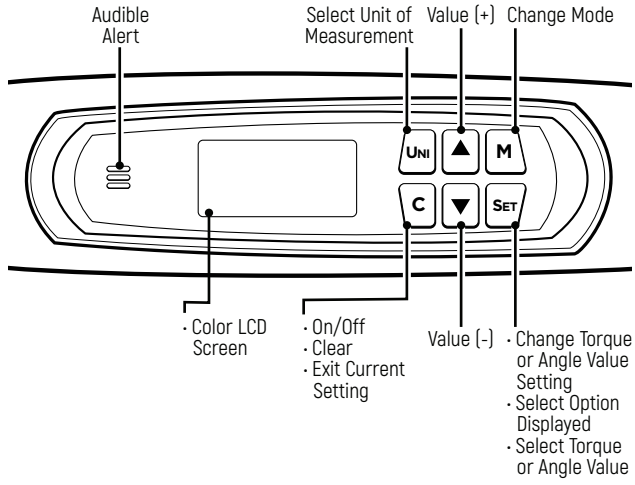

#### 1. Power On

1. Verify torque is not being applied to the wrench. Press **C** for 1 second. Wrench will beep once.
2. The wrench will default to Peak Torque Mode. The last unit of measurement and last torque setting will display.
3. **The wrench is ready to use.**

#### 2. Power Off

1. If no torque is applied, wrench will shut off automatically after 180 seconds.
2. To shut off manually, verify torque is not being applied then press **C** for 3 seconds.

#### 3. How to Change Unit of Torque Measurement

1. Power on the wrench as described in **Section 1**.
2. Press **UNI** repeatedly to select one of the five torque measurement options:
  - Kg-m
  - Nm
  - Ft-lb
  - In-lb
  - Kg-cm
3. The wrench is ready to use.

#### 4. How to Set Mode

1. There are five mode options:
    - P = Peak Torque (default)
    - A = Angle
    - PA = Peak Angle
    - Pct = Target Torque Alert Setting
    - trAc = Tracking Mode (Optional)
  2. Power on the wrench as described in **Section 1**.
  3. Press **M** repeatedly to scroll through the different modes. "SEL" will show at the top of the screen to indicate the mode being selected. The currently selected mode will still show as an option when scrolling through modes.
  4. Press **SET** to select the new mode. The screen will show the last setting for the mode selected.
- Note: To exit out of setting mode without changing the mode, press **C**. The current mode and setting will remain unchanged.

#### 5. How to Set Target Torque in "Peak Torque" Mode

1. Power on the wrench as described in **Section 1**.
2. Press **SET**. The current torque will display on screen, with "tor" sign flashing.
3. The unit of torque measurement can also be adjusted at this time. Press **UNI** to change it if required.
4. Press **▲** or **▼** to select torque value, then press **SET**.
5. **The wrench is ready to use.**
6. Apply torque and rotate the wrench at a **constant moderate speed** until alerted to stop by the handle vibration, beeps and LCD display. The LCD screen will flash when the "target torque alert" warning starts. As the target torque is reached, the torque reading will flash, and handle will vibrate.

Note: After reaching the target torque the display will flash for 10 seconds, then default to the last setting. The next measurement can be taken while the screen is flashing by applying force again, or by pressing **C** to return to the last setting.

#### 6. How to Set Angle

1. Power on the wrench as described in **Section 1**.
2. Press **M** until the "A" mode is reached, then press **SET**.
3. The screen will show the last angle value set.
4. If desired angle is displayed, the wrench is ready to use.
5. If you want a different angle, press **SET** again to change the angle degree. Press **▲** or **▼** to get to the required angle, then press **SET**.
6. **The wrench is ready to use.**
7. Apply torque and rotate the wrench at a **constant moderate speed** until alerted to stop by the handle vibration, beeps and LCD display.
8. To take the next measurement press **C** or wait until the display stops flashing.

Note: After reaching the target angle the display will flash for 10 seconds, then default to the last setting.  
For better accuracy the torque wrench should be rotated between 10 degree/sec – 180 degrees/sec.

#### 7. How to Change "Target Torque Alert" and "Target Angle Alert" Percentages

1. Power on the wrench as described in **Section 1**.
2. Press **M** until the "Pct" mode is reached, then press **SET**.
3. The current value will display on the screen with "tor" sign flashing.
4. Press **▲** or **▼** to select when the target torque alert will start. The target torque alert can start at a maximum of 50% to the target torque value or a minimum of 15% to the target torque value. For example, if your target torque is 100 ft-lbs and your target torque alert is set at 50%, the alert will start when you reach 50 ft-lbs. Press **SET** to save.
5. The screen will show "Ang" so the target angle alert can be adjusted.
6. Press **SET** to change the target angle alert setting. Press **▲** or **▼** to select when the target angle alert will start. The target angle alert can start at a maximum of 90 degrees before the target angle or a minimum of 15 degrees before the target angle. Press **SET** to save.
7. **The wrench is ready to use.**

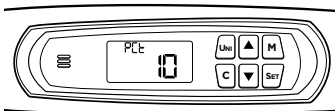

#### 8. How to Use Pre-Set Torque Values

1. Power on the wrench as described in **Section 1**.
2. Press **SET** then **M**. The screen will show the flashing setting number and the torque value will be displayed.
3. Press **▲** or **▼** to select the desired pre-set torque value, then press **SET**.
4. **The wrench is ready to use.**

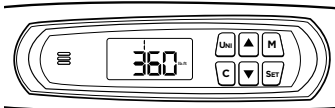

#### 9. How to Change Pre-Set Torque Values

- Pre-Set Torque Values can only be selected in Peak or Peak Angle modes.
1. Power on the wrench as described in **Section 1**.
  2. Press **SET** then **M**. The screen will show flashing setting number and the torque value will be displayed.
  3. Press **▲** or **▼** to select the desired pre-set torque value, then press **M** for 1 second, the flashing setting number will turn into flashing "tor" sign.
  4. Now the "tor" sign at the top of the sign will flash. Press **▲** or **▼** to select the desired torque setting, then press **SET**. The new Pre-Set Value is saved into the Pre-Set options.
  5. Press **SET** again to set the target torque as to the new Pre-set value.

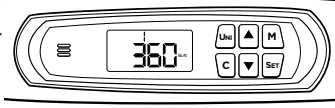

#### 10. How to Set Torque with Angle

1. Power on the wrench as described in **Section 1**.
  2. Press **M** until the "PA" mode is reached, then press **SET**.
  3. If the desired angle and torque values are displayed, the **wrench is ready to use.**
  4. If you want a different torque value or angle, press **SET** again.
  7. To change the torque value press **▲** or **▼** to get to the required value, then press **SET**. The screen will show "Ang" sign on top part of the screen. If the target angle value previously displayed is correct, press **C** to exit.
  8. After setting the torque value, the screen will show "ANG". Press **SET** to review or change the angle value. Press **▼** or **▲** to get to the required angle value, then press **SET** again.
  9. **The wrench is ready to use.**
  10. Apply torque and rotate the wrench at a **constant moderate speed** until alerted to stop by the handle vibration, beeps and LCD display.
- Note: After reaching the target torque the wrench will start recording the angle measurement. After reaching the target torque and target angle the display will flash for 10 seconds, then default to the last setting. To take the next measurement press **C** or wait until the display stops flashing.

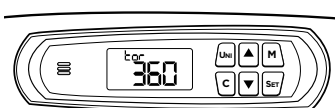
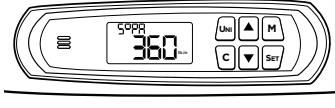
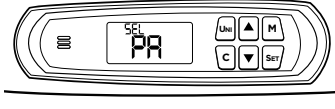

#### 11. Low Battery Indication

1. 100%-80% High Battery
2. 80%-50% Mid Battery
3. 50%-10% Low Battery
4. Lower than 10% - Flashing

#### 12. Changing Batteries

1. Use AA (Alkaline) Batteries only.
2. Remove Batteries if the torque wrench is not used for an extended period of time.
3. Unscrew end cap
4. Insert 2 AA (Alkaline) Batteries
5. Replace End Cap

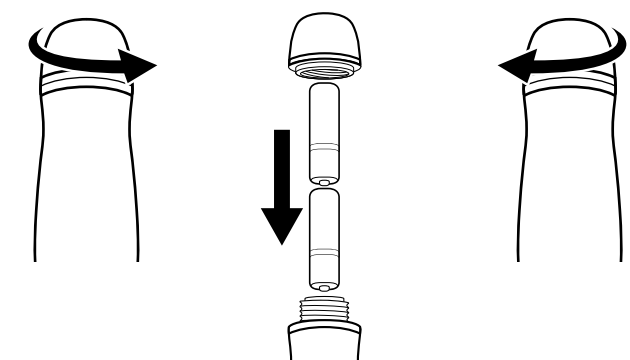

#### 13. Maximum Capacity Exceeded

1. When the applied torque exceeds the wrench full-scale capacity the LCD screen will show red. The display will show "ovEr".
2. Verify the calibration of the wrench if you know its capacity has been exceeded.

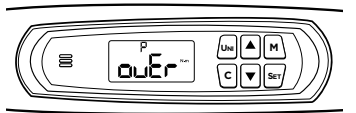

#### 14. Tracking Mode

1. Power on the wrench as described in **Section 1**.
2. Press **M** to scroll through the different modes
3. Select "trAc" to enter Tracking Mode. There will be a T sign next to the battery indication.
4. In this mode, there will be not target torque or angle value. The display will show the real time torque and value applied to the wrench.
5. You may press **C** to reset the angle value to 0

#### How to Apply Torque

1. This Electronic Torque Wrench is designed so that when force is properly applied to the handgrip, a continuous audible signal, the LCD screen display and vibration in the handle will indicate that the Target Torque or Angle has been attained. **DO NOT** pull beyond this point.
2. To properly apply torque, attach socket securely on torque wrench square drive and position socket on fastener so that tilting will not occur. Grasp the center of hand grip and apply a slow steady increasing force perpendicular (90 degrees) to the torque wrench body and perpendicular (90 degrees) to the center line of the square drive, socket and fastener.
3. Turn the fastener down with a smooth and even force applied to the handle of the torque wrench. As turning resistance increases, pull more slowly. To assure accuracy, the fastener must be in motion when the torque measurement is made.

WARNING: Any change from the above procedure will result in a change of torque being applied. This includes standard torque wrenches, flex-head torque wrenches, universal joints, and universal sockets. DO NOT USE universal joints or universal sockets due to the complexity of determining the associated error. If you need angular access, use a flex-head torque wrench.

#### Extensions

When it is necessary to use an extension that changes the effective lever length of the torque wrench, torque being applied will change.

Compute adjustments as follows:

- TW - Torque set on Wrench
- TE - Torque applied by the extension to the fastener

$$TW = (TE \times L) / (L + E)$$

$$TE = (TW \times (L + E)) / L$$

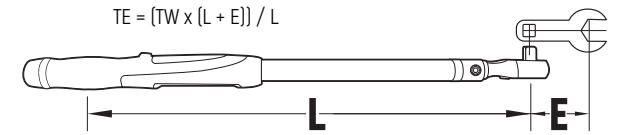

Notice: Socket extension bars that are axially in line with the square drive do not cause error and need no adjustment.  
Apply torque and rotate the wrench at a constant moderate speed until alerted to stop by the continuous audible signal, the LCD Screen display and handle vibration.

#### Certification

This torque wrench was calibrated prior to shipment from the factory within tolerance limits of:

- Torque (unflexed): +/- 2% CW, +/- 3% CCW from 20% to 100% of capacity
- Angle: [+/- 1% of reading] + [+/- 1 degree @ angular velocity >10 degree/sec <180 degree/sec] + [+/- 1 degree of test fixture]

#### Limited Warranty

Until one year from the date of purchase, we will repair any defect in material or workmanship free of charge. Improper use of these products, including but not limited to the application of excessive force, will affect performance and may result in injury. The warranty does not apply to wrenches which do not function properly or within specified accuracy because of wear, improper or unreasonable use, damage not resulting from defect or malfunction, or which have been altered. Calibration is warranted for 90 days. This warranty gives you specific legal rights, and you may also have other rights which vary from state to state. For certified GEARWRENCH repair, service, and calibration center information, please visit GEARWRENCH.com.

## WARNING

- **Never use the torque wrench with the power off. Always turn on the torque wrench so the applied torque is measured.**
- **Do not press any key while torque is being applied.**
- **Do not use electronic torque wrench to loosen fasteners.**
- **Verify the calibration of the wrench if you know or suspect its capacity has been exceeded.**
- **Periodic recalibration is required to maintain accuracy.**
- **Never apply more torque than the maximum wrench capacity or the maximum fastener specifications.**
- **Do not immerse in fluids.**
- **Do not use on live electrical circuits.**
- **Electrical shock can cause injury. Rubber handle is NOT insulated.**



